

ТЕЛЕФОННЫЕ КЛАВИАТУРЫ

AK-207

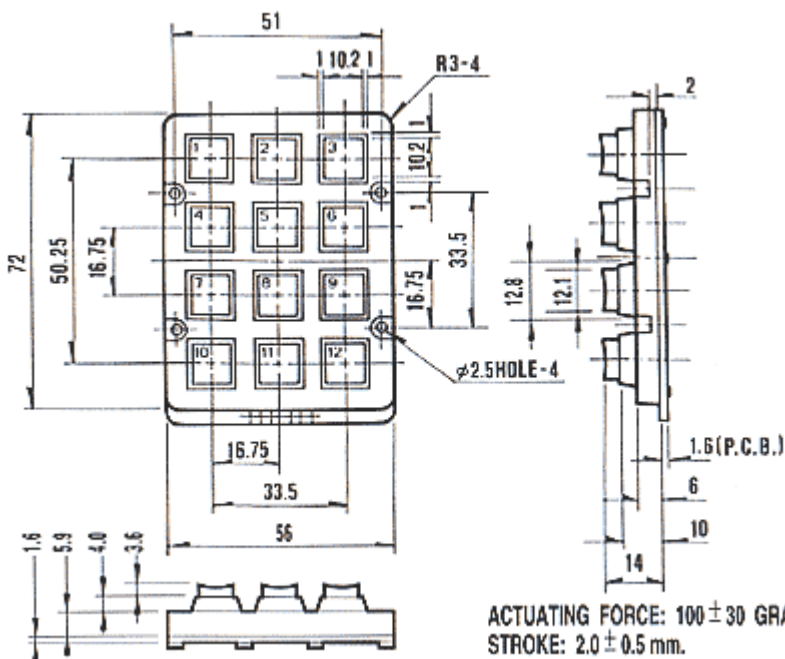

AK-304

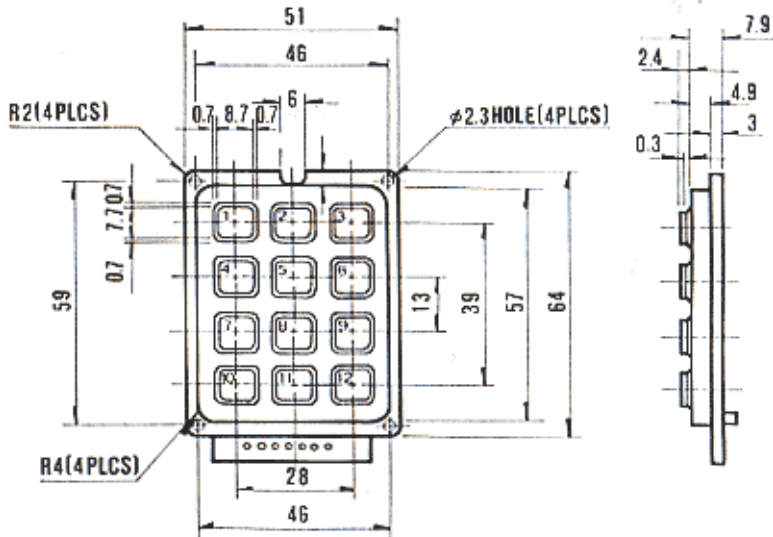

ACTUATING FORCE: 100 ± 30 GRAMS.
STROKE: 1.4 ± 0.4 mm.

AK-507

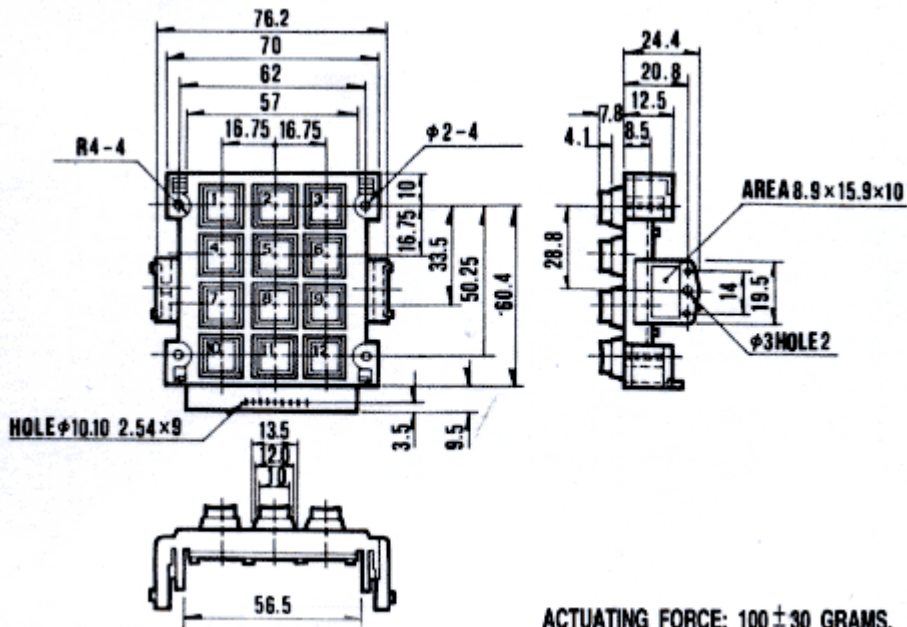

ACTUATING FORCE: 100 ± 30 GRAMS.
STROKE: 2.0 ± 0.5 mm.

AK-707

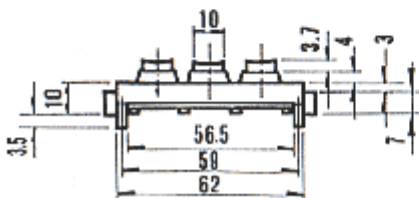
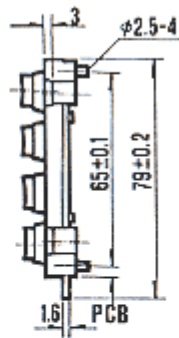
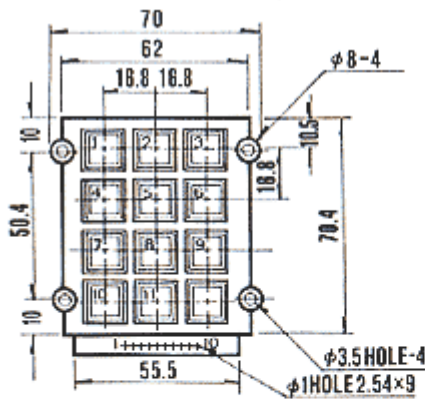

ACTUATING FORCE: 100 ± 30 GRAMS.
STROKE: 2.0 ± 0.5 mm.

AK-804

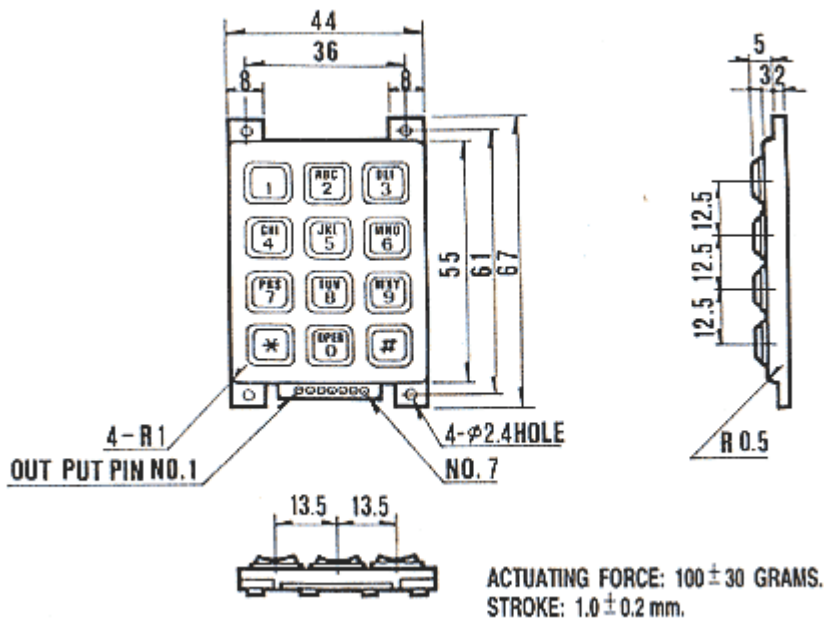
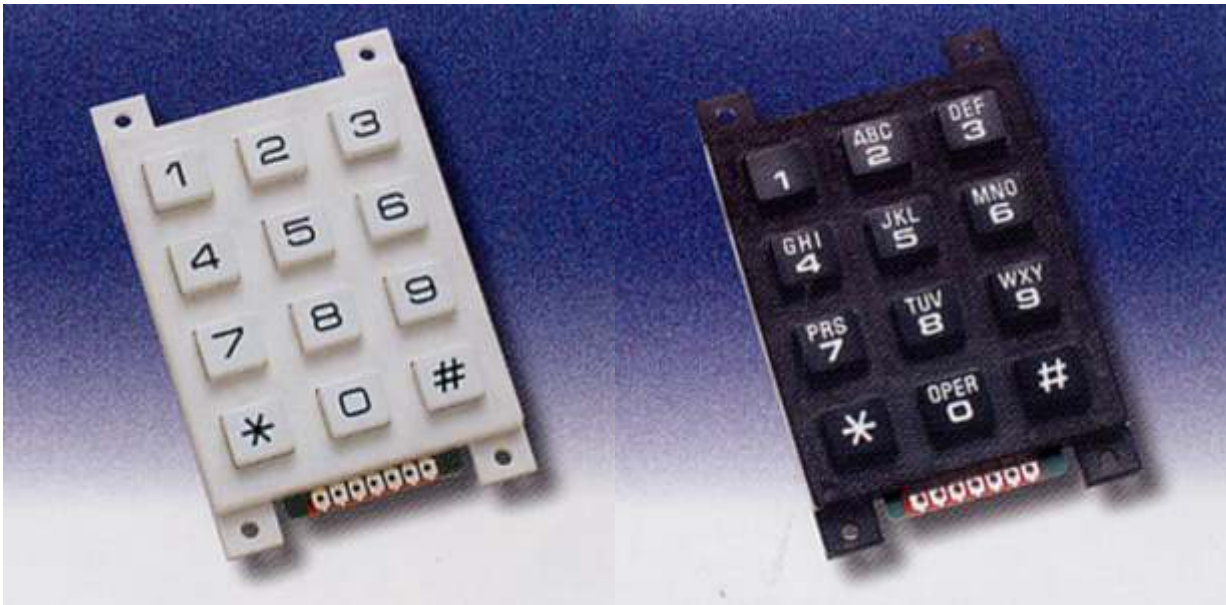

AK-1604

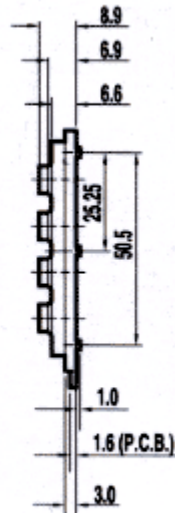
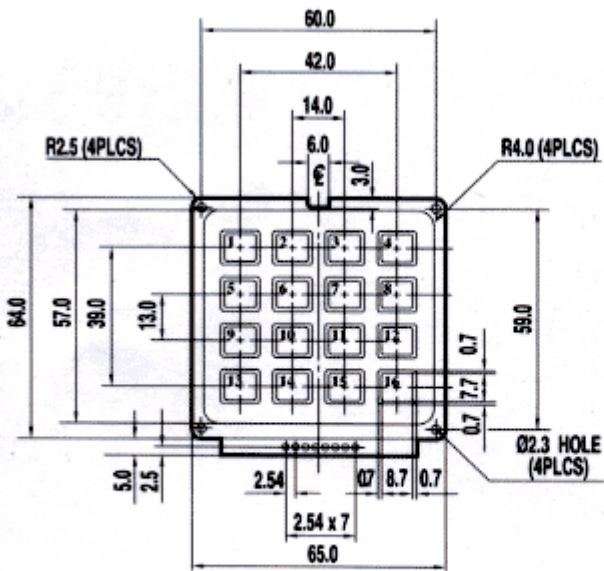

ACTUATING FORCE: 100 ± 30 GRAMS.
STROKE: 1.5 ± 0.5 mm.

AK-1607

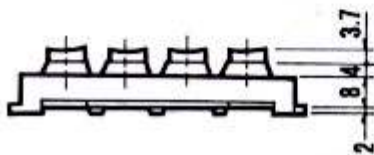
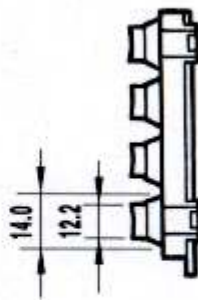
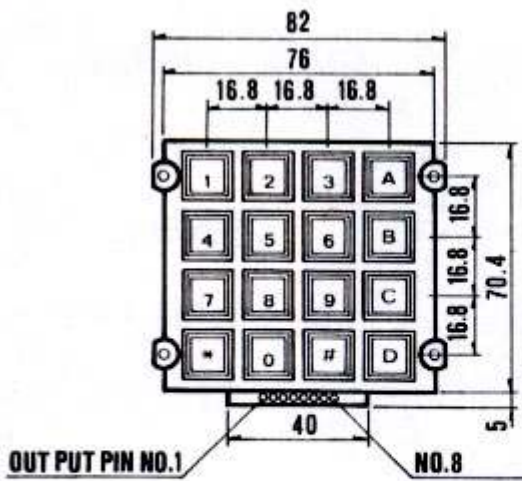

ACTUATING FORCE: 100 ± 30 GRAMS.
STROKE: 2.0 ± 0.5 mm.

AK-1607 металл

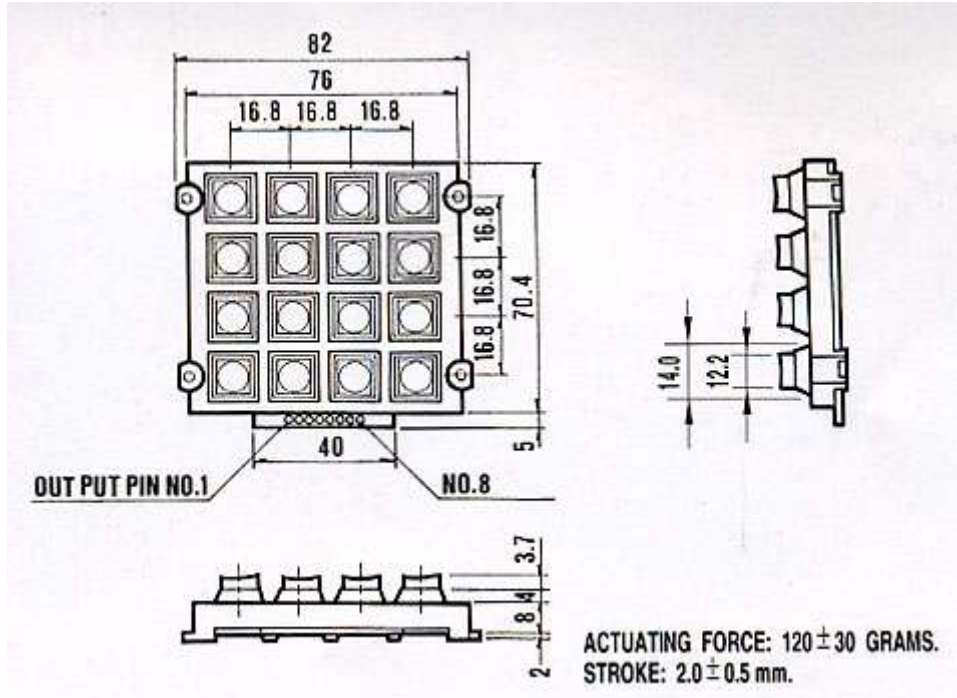
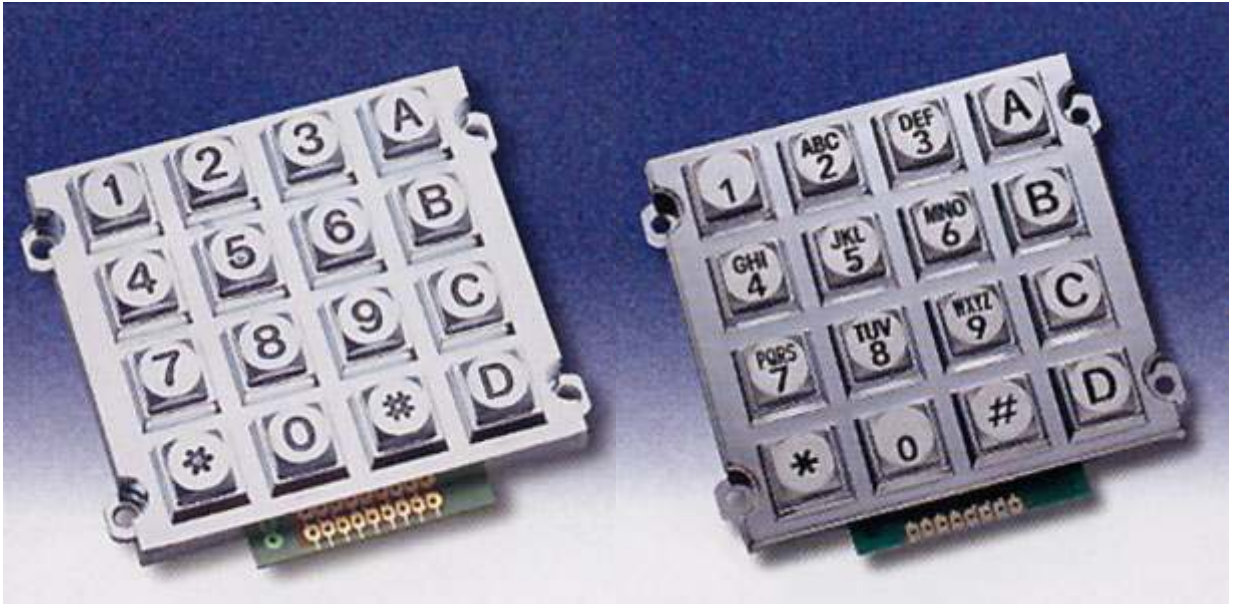

Основные параметры:

Режим работы контактов 24В 20мА
 Сопротивление контактов <200 Ом
 Ресурс 1000000 циклов на контакт
 Рабочая температура -20 +60С

Система обозначений: $\frac{AK-207-N-SSB-WP-MM}{1\ 2\ 345\ 6\ 7}$

1) Номер модели	207, 304, 304FM, 507, 707, 804, 1604, 1607	4) Цвет кнопок	W - белый B - черный G - серый I - слоновая кость S - серебристый (для металлических панелей)
2) Тип символов	A (алфавитно-цифровая) N (числовая)	5) Цвет символов	W - белый B - черный
3) Цвет панели	W - белый B - черный G - серый I - слоновая кость S - серебристый (для металлических панелей)	6) Водонепроницаемость	WP
		7) Металл	MM

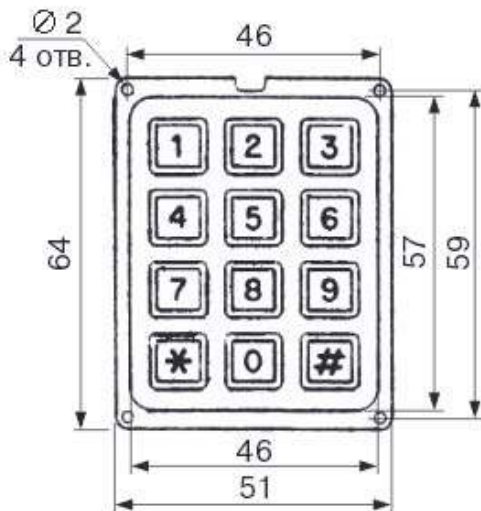
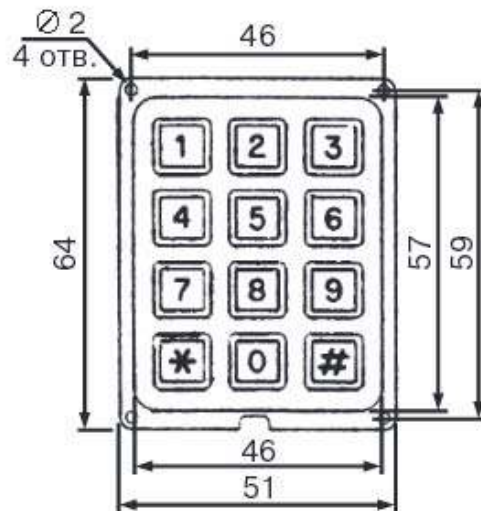
TF-0282**TF-0284**

TF-0286

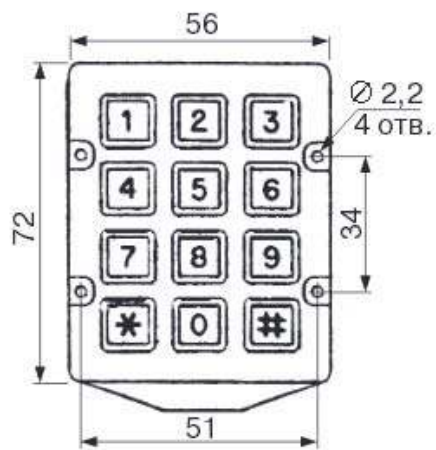

TF-0286-1

