

# Surface mounted

## KP-1102-S SURFACE MOUNTED

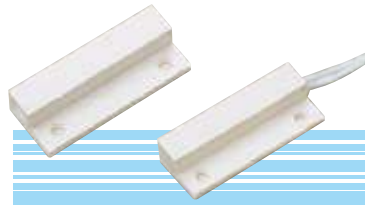

### DIMENSIONS



Available in Closed loop, Open SPDT  
ABS Housing

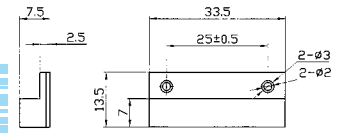

Top View

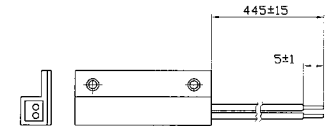

Side View

all dimensions are in mm

**Model No**

**KP-1102-S**

Contact Mode	COM.,N/O,N/C
Standard Gap	Up to 1' / 8"
Rated Current	300mA
Rated Voltage	200VDC
Rated Power	3w
N.W/G.W	9.5 / 10 kgs
Meas/QTY	30 □ 25 □ 32cm / 500pcs

\* Value applying at rated voltage

## KP-2202-S SURFACE MOUNTED



### DIMENSIONS

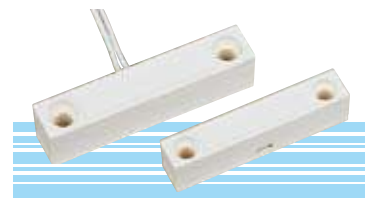

Available in Closed loop, Open SPDT  
ABS Housing

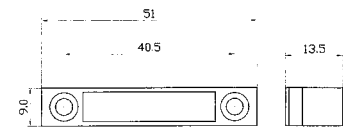

Top View

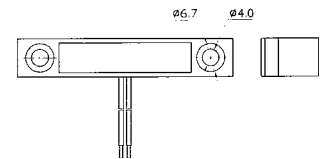

Side View

all dimensions are in mm

**Model No**

**KP-2202-S**

Contact Mode	COM.,N/O,N/C
Standard Gap	Up to 1' / 4"
Rated Current	500mA
Rated Voltage	200VDC
Rated Power	10 w
N.W/G.W	17 / 17.5 kgs
Meas/QTY	30 □ 25 □ 32cm / 50pcs

\* Value applying at rated voltage

## KP-1202-S SURFACE MOUNTED



### DIMENSIONS



Available in Closed loop, Open SPDT  
ABS Housing

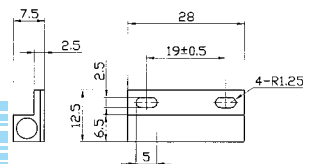

Top View

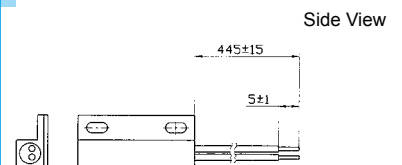

Side View

all dimensions are in mm

**Model No**

**KP-1202-S**

Contact Mode	COM.,N/O,N/C
Standard Gap	Up to 1"
Rated Current	100mA
Rated Voltage	200VDC
Rated Power	3 w
N.W/G.W	9.5/ 10kgs
Meas/QTY	30 □ 25 □ 32cm / 500pcs

\* Value applying at rated voltage

The information contained herein is believed to be correct, but no guarantee for accuracy, completeness KEPO Electronics Ltd reserves the right to make changes without notification.

**KP-1301-R RECESSED MOUNTED**



**DIMENSIONS**



Available in Closed loop, Open SPDT  
ABS Housing

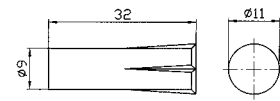

Top View

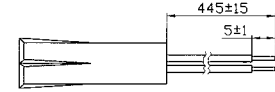

Side View

all dimensions are in mm

<b>Model No</b>	<b>KP-1301-R</b>
Contact Mode	COM.,N/O,N/C
Standard Gap	Up to 1"
Rated Current	100mA
Rated Voltage	100VDC
Rated Power	3 w
N.W/G.W	6.5 / 7.0 kgs
Meas/QTY	30 □ 25 □ 32cm / 1000pcs

\* Value applying at rated voltage

**KP-130MD-R RECESSED MOUNTED**



**DIMENSIONS**



Available in Closed loop, Open SPDT  
ABS Housing

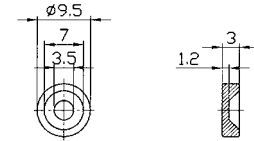

Top View

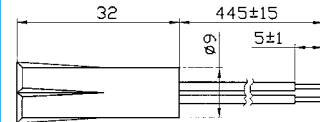

Side View

all dimensions are in mm

<b>Model No</b>	<b>KP-1301MD-R</b>
Contact Mode	COM.,N/O,N/C
Standard Gap	Up to 5/8"
Rated Current	100mA
Rated Voltage	100VDC
Rated Power	3 w
N.W/G.W	6.5 / 7.0 kgs
Meas/QTY	30 □ 25 □ 32cm / 1000pcs

\* Value applying at rated voltage

**KP-1401-R RECESSED MOUNTED**



**DIMENSIONS**

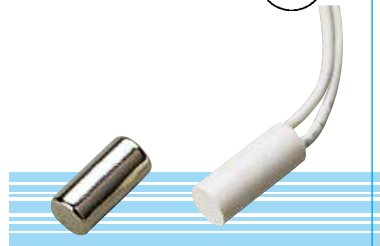

Available in Closed loop, Open SPDT  
ABS Housing

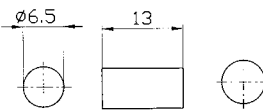

Top View

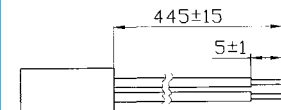

Side View

all dimensions are in mm

<b>Model No</b>	<b>KP-1401-R</b>
Contact Mode	COM.,N/O,N/C
Standard Gap	Up to 3/4"
Rated Current	100mA
Rated Voltage	100VDC
Rated Power	20w
N.W/G.W	6.5 / 7.0 kgs
Meas/QTY	30 □ 25 □ 32cm / 1000pcs

\* Value applying at rated voltage

The information contained herein is believed to be correct, but no guarantee for accuracy, completeness KEPO Electronics Ltd. reserves the right to make changes without notification.

**KP-3101-R RECESSED MOUNTED**



**DIMENSIONS**

Bottom View

<b>Model No</b>	<b>KP-3101-R</b>
Contact Mode	COM.,N/O,N/C
Active Gap	□ 0.6mm □ 2mm
Rated Current	50mA
Rated Voltage	200VDC
Rated Power	10 w



Available in Closed loop, Open SPDT  
ABS Housing

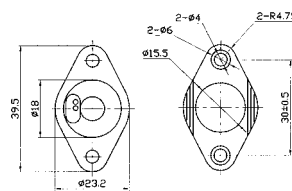

Side View

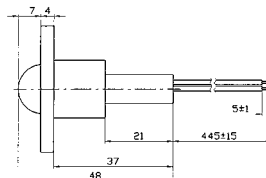

all dimensions are in mm

\* Value applying at rated voltage

**KP-2101T-R RECESSED MOUNTED**



**DIMENSIONS**

Top View

<b>Model No</b>	<b>KP-2101T-R</b>
Contact Mode	COM.,N/O,N/C
Active Gap	□ 40mm □ 60mm
Rated Current	300mA
Rated Voltage	200VDC
Rated Power	10 w
N.W / G.W	7.5/8.0 kgs
Meas/QTY	30 □ □□□ □□□□ □□□□□□□□



Available in Closed loop, Open SPDT  
ABS Housing

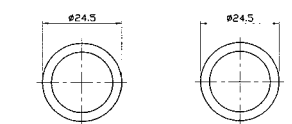

Side View

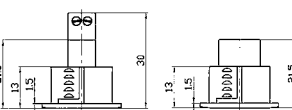

Bottom View

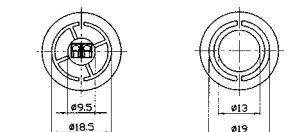

all dimensions are in mm

\* Value applying at rated voltage

**KP-1501-R RECESSED MOUNTED**



**DIMENSIONS**

Side View

<b>Model No</b>	<b>KP-1501-R</b>
Contact Mode	COM.,N/O,N/C
Active Gap	□ 15mm □ 25mm
Rated Current	100mA
Rated Voltage	100VDC
Rated Power	20 w
N.W / G.W	7.5/8.0 kgs
Meas/QTY	30 □ □□□ □□□□ □□□□□□□□



Available in Closed loop, Open SPDT  
ABS Housing

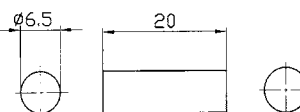

Top View

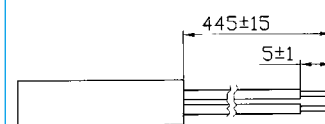

all dimensions are in mm

\* Value applying at rated voltage

The information contained herein is believed to be correct, but no guarantee for accuracy, completeness  
KEPO Electronics Ltd reserves the right to make changes without notification.

**KP-3102-S SURFACE MOUNTED**



**DIMENSIONS**

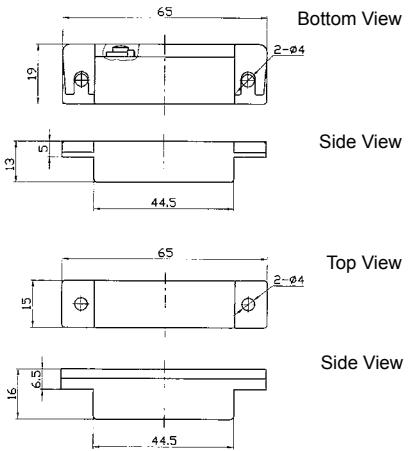

all dimensions are in mm

<b>Model No</b>	<b>KP-3102-S</b>
Contact Mode	COM.,N/O,N/C
Standard Gap	Up to 1 <sup>3</sup> / <sub>4</sub> "
Rated Current	300mA
Rated Voltage	200VDC
Rated Power	3 w
N.W/G.W	12 / 12.5 kgs
Meas/QTY	30 □ 25 □ 32cm / 400pcs

\* Value applying at rated voltage

**KP-4102-SI SURFACE MOUNTED**



**DIMENSIONS**

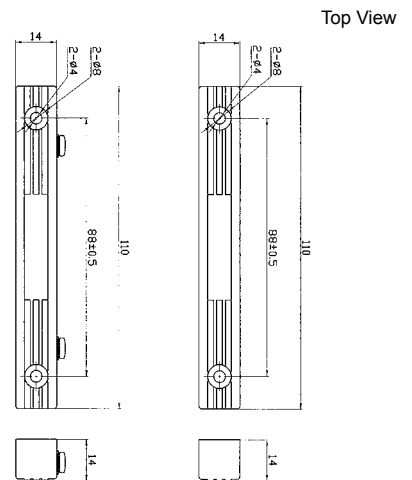

all dimensions are in mm

<b>Model No</b>	<b>KP4102-SI</b>
Contact Mode	COM.,N/O,N/C
Standard Gap	Up to 2 <sup>3</sup> / <sub>4</sub> "
Rated Current	50mA
Rated Voltage	130VDC
Rated Power	20w
N.W/G.W	9.5 / 10 kgs
Meas/QTY	30 □ 25 □ 32cm / 100pcs

\* Value applying at rated voltage

**KP-1103-SD MAGNETIC SWITCHES**



**DIMENSIONS**

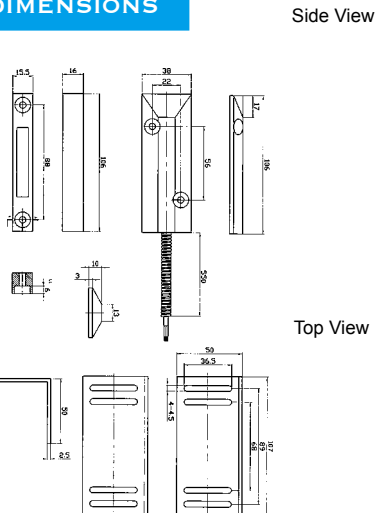
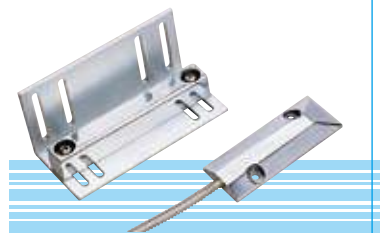

all dimensions are in mm

Color White  
ABS Housing Material

<b>Model No</b>	<b>KP1103-SD</b>
Contact Mode	COM.,N/O,N/C
Standard Gap	Up to 3"ClosedLoop
Rated Current	500mA
Rated Voltage	200VDC
Rated Power	10w
N.W/G.W	13 / 13.5 kgs
Meas/QTY	30 □ 25 □ 32cm / 36pcs

\* Value applying at rated voltage

The information contained herein is believed to be correct, but no guarantee for accuracy, completeness  
KEPO Electronics Ltd. reserves the right to make changes without notification.