

# Push Button Switch

**Q-116**

TYPE: **DS-314**

## SPECIFICATIONS

Rating: 1A 250V AC  
Contact R: 35mΩ max  
Insulation R: 500V DC 100MΩ min  
Dielectric Strength: 1 Minute 1000V AC  
Operating Temperature: -25°C ~ +85°C  
Electrical Life: 10, 000 Cycles

Outline Drawing

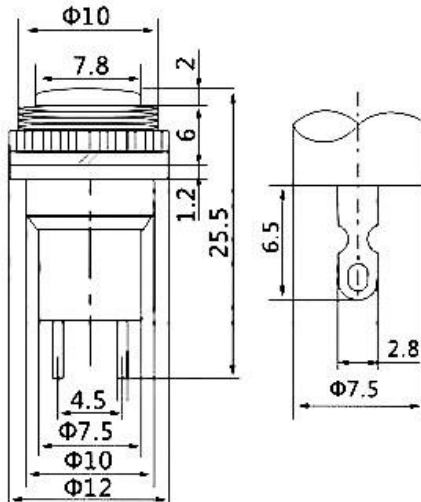

Mounting

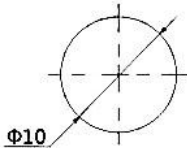

Circuitry

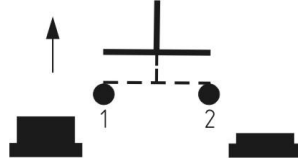

**OFF – (ON)**